

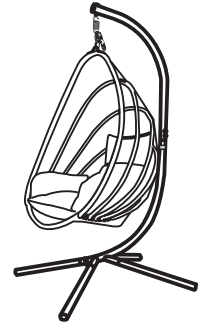



















KINGMAN



Instructions d'assemblage



A.x1 	B.x1 	C.x1 	D.x1 	E.x1 	F.x4 	G.x2  M8x55mm	H.x2  M8	I.x1 	J.x1 
K.x1 	L.x1 	M.x4  M6x16mm	N.x4  M6	O.x12  M6	P.x2  M8	Q.x1  M8	R.x1  M6	S.x1  M4	

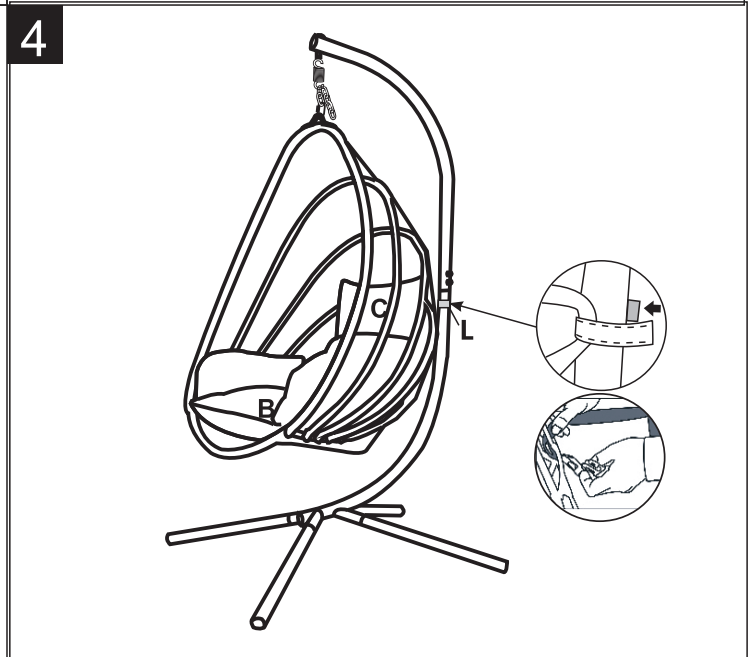
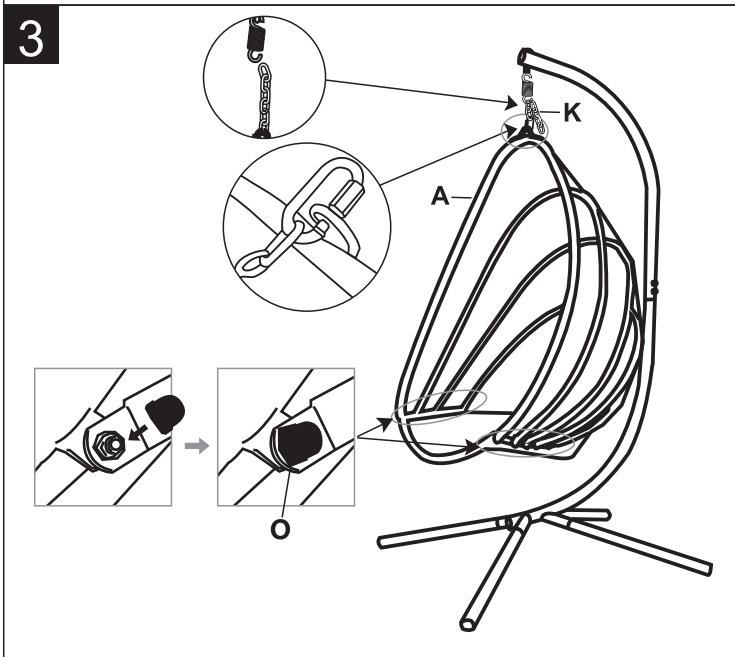
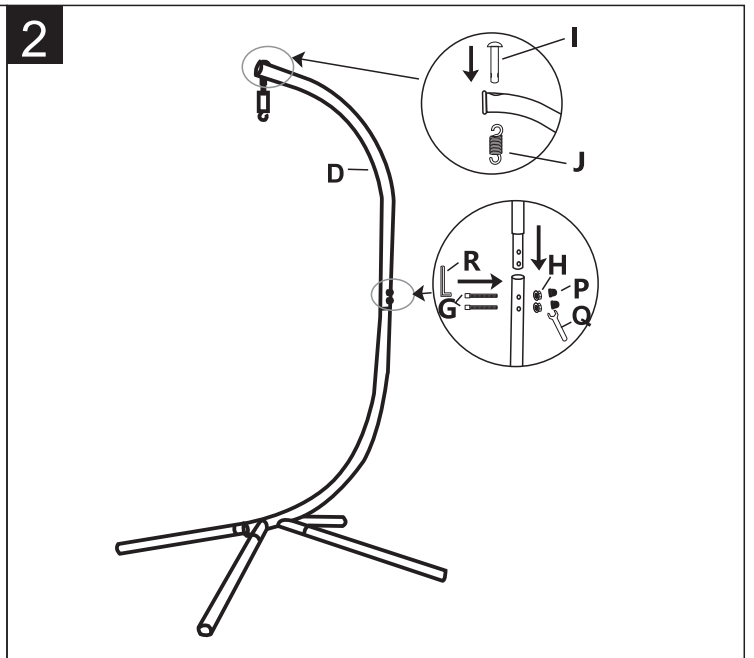
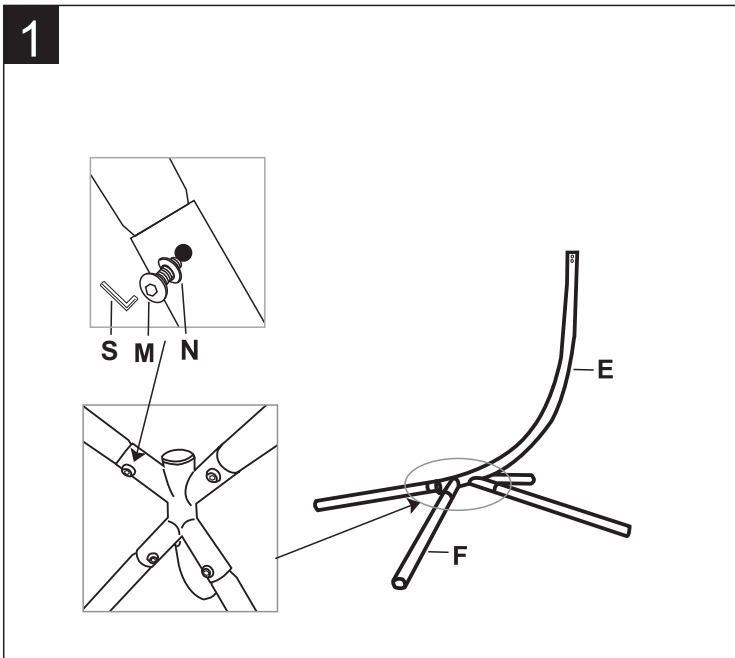

OK

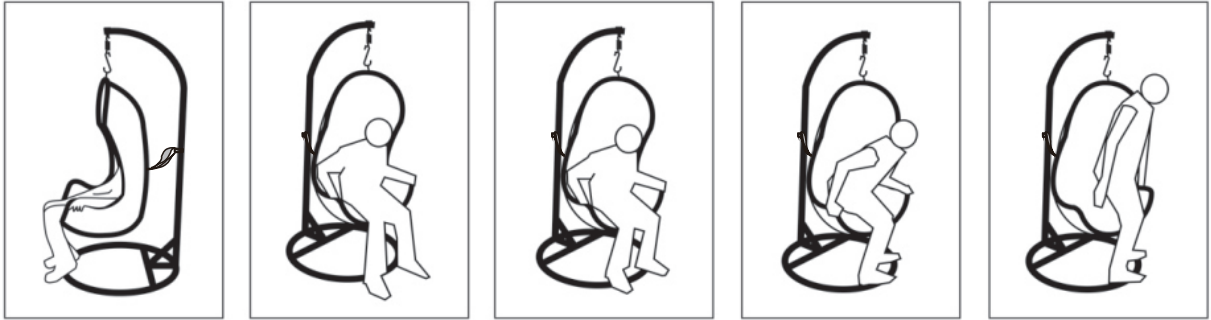

NO

